

10.4" GPS 3D Color Chartplotter & Combo N100/NF100

NEW
Introduction of
3D chart

LED



Sense the reality on the sea



★High speed CPU!!

★Smooth 3D map!!

Equipped with 3D map developed by our own technology!!

Perfect waterproof following international standard (IPX6)!!

◆ Features

- 3D map developed with SAMYUNG ENC' s / NAVIONICS® proprietary technology
- High intensity and high definition display with high resolution TFT LED Applied
- LED backlighting adjustable to 10 different brightness levels
- NAVIONICS® Platinum+ available utilizing SD card input
- Plays movies, videos and music from SD or USB input
- 512/1024MB internal memory and embedded with standard SAMYUNG S-MAP
- Individual navigation GOTO & MOB buttons
- NMEA(0183/2000) interface (AIS, NAVTEX, DSC, Data repeater, Fuel control etc.)
- Multiple language support (English, Chinese, Russian, etc.)
- DGPS (including WAAS, MSAS, EGNOS) provide greatest accuracy possible
- Excellent user friendly menu and icons
- Perfect navigational interface with Auto Pilot / Engine Controls
- Utilizes dual frequency system (50/200 kHz) for detection of small fish groups (NF100)
- Features upgraded auto range, gain output and pulse length in our latest fish finding circuitry (NF100)
- Utilizes high performance transduce for detection of individual and small fish (NF100)

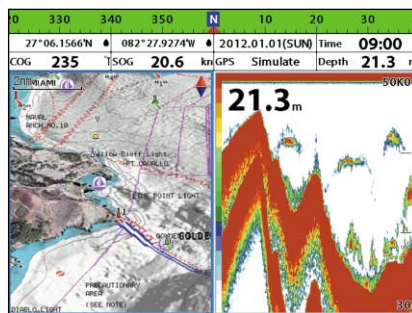

• SAMYUNG 2D/3D MAP can be displayed on high resolution LED

• NAVIONICS® Platinum+ 2D/3D MAP can be displayed on the high resolution LED (SD Card)



• Display multiple functions on split screen

• Two split screen (Chart / Video)

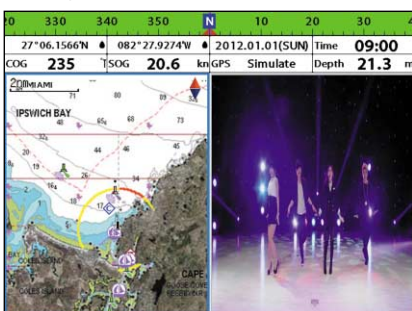

• Three split screen (Chart / Fishfinder / Video)

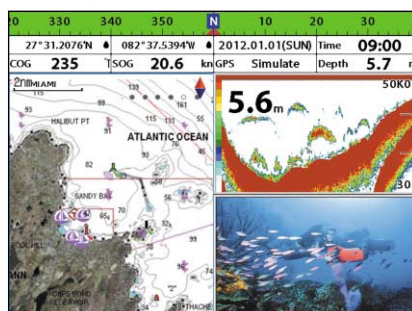

• Four split screen (Chart / Fishfinder / Video / Data)

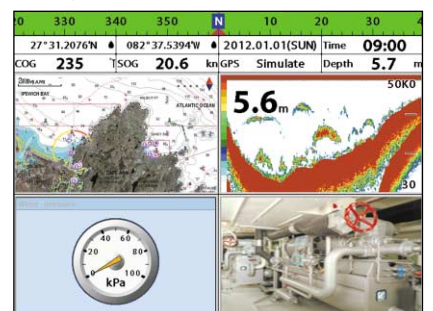

with New **3D** technology !!



★ **Sophisticated Design!!**

★ **Perfect multiplayer!!**

Equipped with the latest digital fish finding circuit !!

Perfect multi player with external equipment !!

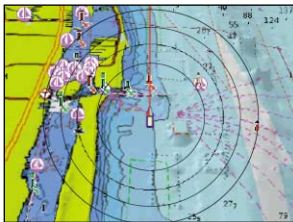

- High sensitivity GPS/DGPS Antenna can be used
- Adopted digital 50 channels multitracer technique
- AIS information can be displayed on the plotter when connected to the compatible AIS receiver (NMEA0183)

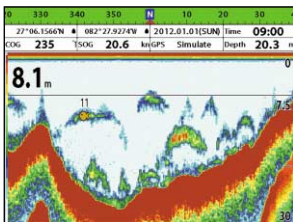

- Represent the fish group in fish shape
- Dual frequency(50/200kHz) transducer (Water temperature, speed sensor)
- Fishfinder screen setting available in Auto/Manual mode and Pause/Playback mode



- Movies, music, video clips can be played using SD CARD or USB drive

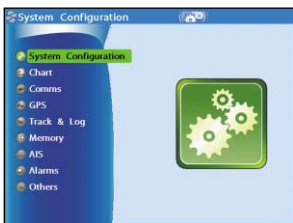

- Choose a page / function by using icon for menu
- Various icons



- User friendly with rotational Encoder key applied which enables to maximize, minimize, and change direction

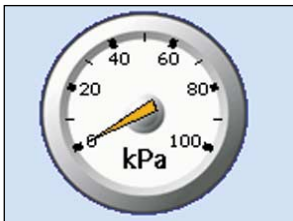

- NMEA 2000 interface
- Data repeater, Fuel control etc.



- Applied SD/USB Media Card Port enables the user to use various function (SD=2SLOT, USB=1SLOT)



- Possible to input the external video
 - CCTV(Composite)= 2Channel
 - S-Video(NTSC/PAL) = 1Channel
- Multi display available with HDMI method



- External Alarm and External speaker can be connected

◆ Specification

Spec.	Model	N100	NF100
Display		10.4" (800 x 600 pixels) LED Backlight	
Receiving channel & Tracking satellite		50 Channels 16 Satellites / Digital 16 Channels multi-tracking type	
Supply voltage		11 to 35 V DC Approx. 40W	
Operating temp.		-10°C ~ 50°C	
Display mode		normal, true-motion, course-up, northup, head-up function	
Alarms		Arrival radius, anchor, XTE, danger, too shallow, too deep, fish, temperature, temperature rate, low battery, low fuel(optional), loss of DGPS fix, radar guard zone, dangerous AIS vessels.	
Chart/User card		SAMYUNG 2D/3D, NAVIONICS® Platinum+ / SD Card 2 slot, USB 1slot	
Waypoints		30,000 waypoints (Event Mark : 48, Mark Color : 16)	
Routes		100 Routes, with up to 100 points each	
Tracks		By time or distance, 10 tracks of 30,000 points	
Chart datums		216 Chart datums(1/2000~1/37,500,000)	
Chart scale		0.2 ~ 500 nm	
Interface		NMEA 0183, NMEA 2000	
Frequency		-	50/200KHz
Output		-	600W/1KW
Depth Range		-	3m~1,500m
Color Display		-	16 colors
Brightness		-	10-step
Screen Moving Speed		-	super fast, fast, medium, low, stop
Battery Voltage Display		-	Voltage number display
AUTO GAIN Adjustment		-	OFF/ON
A-Mode Display		-	OFF/ON
Demo Display		-	OFF/ON
Weak Color Removal		-	0% ~ 75%

◆ Configuration

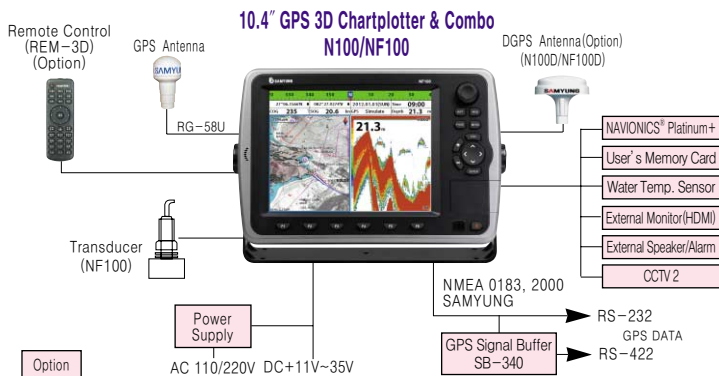

◆ Option

- Power Supply • Remote Control • NAVIONICS® Platinum+ • SD Card
- DGPS Antenna(N100D/NF100D)

◆ Dimensions

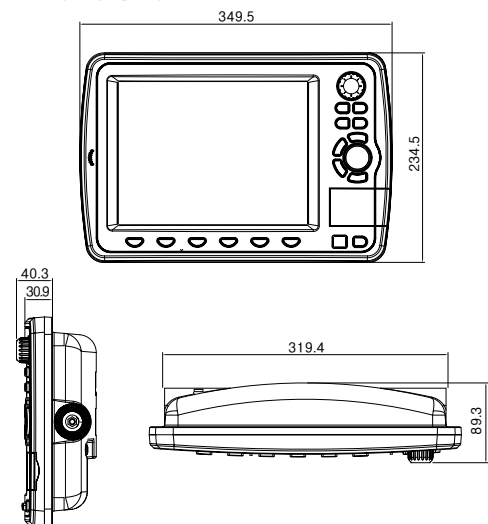

* Specification is subject to change without notice

◆ Component

- GPS 3D Chartplotter & Combo 1Unit
- GPS Antenna(N100/NF100) 1Unit
- Transducer(NF100) 1Unit
- Installation materials, Spare parts, Manual 1Set

SAMYUNG ENC Co.,Ltd.

Head Office : 1123-17, Dongsam-Dong, Youngdo-Gu,
Busan, Korea, 606-083
Tel : 82-51-601-5532(Rep.) Fax : 82-51-413-4446
A/S Center : 65-20, 2-Ga Namhang-Dong, Yungdo-Gu,
Busan, Korea, 606-032
Tel : 82-51-601-5570~4(Rep.) Fax : 82-51-416-5515
Http : //www.samyungenc.com



ISO 9001:2000 / KS A 9001:2001
Certificate No. : RQM0645

